

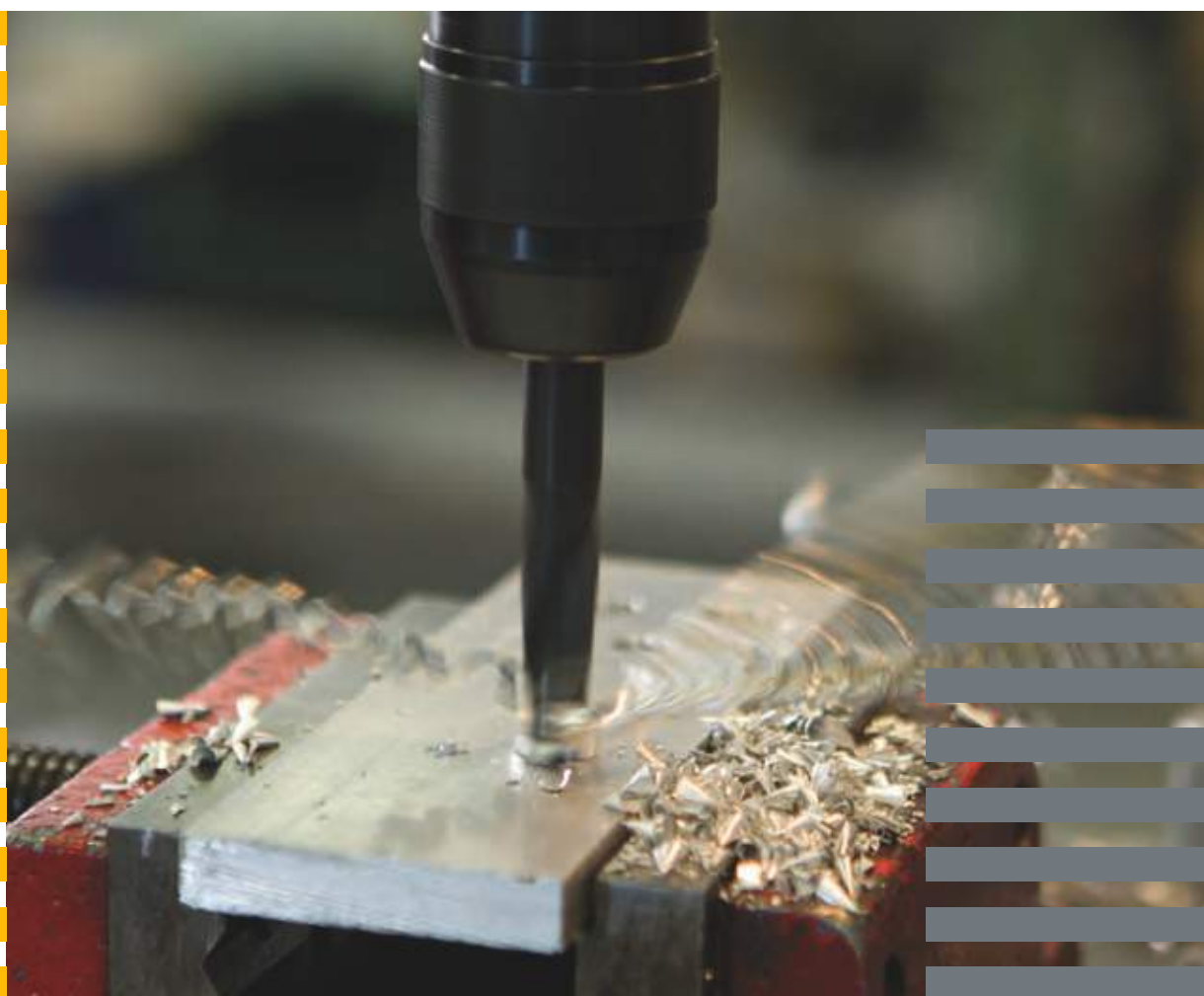

TRAPANI SENSITIVI E MASCHIATRICI DI ALTA PRECISIONE



ARTICOLO		€
Trapani multipli da banco		
	2IM106	2 teste - foratura 6 mm Rich. Offerta
	2IM110	2 teste - foratura 10 mm Rich. Offerta
	2IM115	2 teste - foratura 15 mm Rich. Offerta
	2IM118	2 teste - foratura 18 mm Rich. Offerta
	3IM106	3 teste - foratura 6 mm Rich. Offerta
	3IM110	3 teste - foratura 10 mm Rich. Offerta
	3IM115	3 teste - foratura 15 mm Rich. Offerta
	3IM118	3 teste - foratura 18 mm Rich. Offerta
	4IM106	4 teste - foratura 6 mm Rich. Offerta
	4IM110	4 teste - foratura 10 mm Rich. Offerta
	4IM115	4 teste - foratura 15 mm Rich. Offerta
	4IM118	4 teste - foratura 18 mm Rich. Offerta

ARTICOLO		€
Trapani multipli con basamento		
	2IM106C	2 teste - foratura 6 mm Rich. Offerta
	2IM110C	2 teste - foratura 10 mm Rich. Offerta
	2IM115C	2 teste - foratura 15 mm Rich. Offerta
	2IM118C	2 teste - foratura 18 mm Rich. Offerta
	3IM106C	3 teste - foratura 6 mm Rich. Offerta
	3IM110C	3 teste - foratura 10 mm Rich. Offerta
	3IM115C	3 teste - foratura 15 mm Rich. Offerta
	3IM118C	3 teste - foratura 18 mm Rich. Offerta
	4IM106C	4 teste - foratura 6 mm Rich. Offerta
	4IM110C	4 teste - foratura 10 mm Rich. Offerta
	4IM115C	4 teste - foratura 15 mm Rich. Offerta
	4IM118C	4 teste - foratura 18 mm Rich. Offerta

ARTICOLO		€
Trapani multipli a colonna con tavola mobile		
	2IM115TM	2 teste - foratura 15 mm Rich. Offerta
	2IM118TM	2 teste - foratura 18 mm Rich. Offerta
	3IM115TM	3 teste - foratura 15 mm Rich. Offerta
	3IM118TM	3 teste - foratura 18 mm Rich. Offerta

ARTICOLO		€
Trapani/Maschiatrici multipli da banco		
	2IMM110	2 teste - foratura 10 mm maschiatura 6x0,75 M Rich. Offerta
	2IMM118	2 teste - foratura 18 mm maschiatura 12x1,5 M Rich. Offerta
	3IMM110	3 teste - foratura 10 mm maschiatura 6x0,75 M Rich. Offerta
	3IMM118	3 teste - foratura 18 mm maschiatura 12x1,5 M Rich. Offerta
	4IMM110	4 teste - foratura 10 mm maschiatura 6x0,75 M Rich. Offerta
	4IMM118	4 teste - foratura 18 mm maschiatura 12x1,5 M Rich. Offerta

ARTICOLO		€
Trapani/Maschiatrici multipli con basamento		
	2IMM110C	2 teste - foratura 10 mm maschiatura 6x0,75 M Rich. Offerta
	2IMM118C	2 teste - foratura 18 mm maschiatura 12x1,5 M Rich. Offerta
	3IMM110C	3 teste - foratura 10 mm maschiatura 6x0,75 M Rich. Offerta

ARTICOLO		€
	3IMM118C	3 teste - foratura 18 mm maschiatura 12x1,5 M Rich. Offerta
	4IMM110C	4 teste - foratura 10 mm maschiatura 6x0,75 M Rich. Offerta
	4IMM118C	4 teste - foratura 18 mm maschiatura 12x1,5 M Rich. Offerta

ARTICOLO		€
Trapani/Maschiatrici a colonna con tavola mobile		
	2IMM118TM	2 teste - foratura 18 mm maschiatura 12x1,5 M Rich. Offerta
	3IMM118TM	3 teste - foratura 18 mm maschiatura 12x1,5 M Rich. Offerta

ARTICOLO		€
Trapani		
	IM103	da banco foratura acciaio 3 mm 4.438,00

	IM106	da banco foratura acciaio 6 mm 4.438,00
	IM110	da banco foratura acciaio 10 mm 4.238,00

	IM106C	con basamento foratura acciaio 6 mm 6.555,00
	IM110C	con basamento foratura acciaio 10 mm 6.355,00

	IM115	da banco foratura acciaio 15 mm 4.840,00
--	-------	---

ARTICOLO	€
 IM115C Trapano con basamento foratura acciaio 15 mm	6.958,00

Trapani a colonna

 IM115TM tavola mobile foratura acciaio 15 mm	10.615,00
IM118TM tavola mobile foratura acciaio 18 mm	10.672,00

Trapani

 IM118 da banco foratura acciaio 18 mm	4.898,00
---	-----------------

 IM118C con basamento foratura acciaio 18 mm	7.015,00
--	-----------------

Trapani a colonna

 IM125TG tonda-tavola girevole foratura acciaio 25 mm	21.331,00
IM132TG tonda-tavola girevole foratura acciaio 32 mm	22.883,00

 IM125TM tavola mobile foratura acciaio 25 mm	19.599,00
IM132TM tavola mobile foratura acciaio 32 mm	21.151,00

Trapani/Maschiatrici

 IMM110 da banco foratura acciaio 10 mm maschiatura acciaio 6x0,75 M	5.063,00
IMM118 da banco foratura acciaio 18 mm maschiatura acciaio 12x1,5 M	5.300,00

ARTICOLO	€
----------	---

Trapani/Maschiatrici

 IMM110C con basamento foratura acciaio 10 mm maschiatura acciaio 6x0,75 M	7.178,00
IMM118C con basamento foratura acciaio 18 mm maschiatura acciaio 12x1,5 M	7.415,00

Trapani/Maschiatrici a colonna

 IMM118TM tavola mobile foratura acciaio 18 mm maschiatura acciaio 12x1,5 M	11.086,00
---	------------------

Trapani/Maschiatrici a colonna

IMM125ATG tonda-tavola girevole avanzamenti elettronici foratura acciaio 25 mm maschiatura acciaio 18 M	29.973,00
 IMM125TG tonda-tavola girevole foratura acciaio 25 mm maschiatura acciaio 18 M	21.435,00
IMM132ATG tonda-tavola girevole avanzamenti elettronici foratura acciaio 30 mm maschiatura acciaio 20 M	30.743,00
IMM132TG tonda-tavola girevole foratura acciaio 30 mm maschiatura acciaio 20 M	22.985,00

IMM125ATM tavola mobile avanzamenti elettronici foratura acciaio 25 mm maschiatura acciaio 18 M	28.240,00
 IMM125TM tavola mobile foratura acciaio 25 mm maschiatura acciaio 18 M	19.701,00
IMM132ATM tavola mobile avanzamenti elettronici foratura acciaio 30 mm maschiatura acciaio 20 M	29.010,00
IMM132TM tavola mobile foratura acciaio 30 mm maschiatura acciaio 20 M	21.252,00



ARTICOLO €
Trapani/Maschiatrici a controllo numerico

	IMM132TGCN	tavola girevole colonna tonda foratura acciaio 30 mm maschiatura acciaio 24 M	fuori prod.
	IMM132TGCN-I4.0	tavola girevole colonna tonda foratura acciaio 30 mm maschiatura acciaio 24 M impianto di illuminazione impianto di refrigerazione macchina con predisposizione per industria 4.0	36.500,00
	IMM132TMCN	tavola mobile foratura acciaio 30 mm maschiatura acciaio 24 M	fuori prod.
	IMM132TMCN-I4.0	tavola mobile su guide prismatiche foratura acciaio 30 mm maschiatura acciaio 24 M impianto di illuminazione impianto di refrigerazione macchina con predisposizione per industria 4.0	34.800,00

Trapano/Maschiatrice

	IMM150M	testa motorizzata foratura acciaio 60 mm maschiatura acciaio 39 M	Rich. Offerta
--	----------------	---	----------------------



Trapani/Maschiatrici a colonna

	IMM235ATM	tavola mobile foratura acciaio 35 mm maschiatura acciaio 30 M avanzamenti elettronici	47.511,00
	IMM235TM	tavola mobile foratura acciaio 35 mm maschiatura acciaio 30 M	38.915,00



Maschiatrici automatiche a patrona

	IMMP120	da banco maschiatura acciaio 16x2 M	12.939,00
	IMMP120C	con basamento maschiatura acciaio 16x2 M	14.458,00
	IMMP120S	da banco maschiatura acciaio 10x1,5 M	12.510,00
	IMMP120SC	con basamento maschiatura acciaio 10x1,5 M	14.029,00





ARTICOLO €
Maschiatrici automatiche a patrona

	IMMP120STM	a colonna tavola mobile maschiatura acciaio 10x1,5 M	16.709,00
	IMMP120TM	a colonna tavola mobile maschiatura acciaio 16x2 M	17.138,00
	IMMP235TM	a colonna tavola mobile maschiatura acciaio 30 M	40.955,00

Trapani/Maschiatrici a colonna tavola mobile

	IMMV235ACR-TM	foratura acciaio 35 mm maschiatura acciaio 30 M avanzamento e variazione elettronici cambio rapido utensile	57.503,00
	IMMV235ATM	foratura acciaio 35 mm maschiatura acciaio 30 M avanzamento e variazione elettronici	54.041,00
	IMMV235ATM-TC3	foratura acciaio 35 mm maschiatura acciaio 30 M avanzamento e variazione elettronici e tavola a croce di precisione	Rich. Offerta

Trapani/Maschiatrici



	IMMVE110	da banco foratura acciaio 10 mm maschiatura acciaio 8x1 M variazione elettronica	8.218,00
	IMMVE118	da banco foratura acciaio 18 mm maschiatura acciaio 14x1,75 M variazione elettronica	8.620,00
	IMMVE110C	con basamento foratura acciaio 10 mm maschiatura acciaio 8x1 M variazione elettronica	10.338,00
	IMMVE118C	con basamento foratura acciaio 18 mm maschiatura acciaio 14x1,75 M variazione elettronica	10.740,00
	IMMVE118TM	a colonna foratura acciaio 18 mm maschiatura acciaio 14x1,75 M tavola mobile variazione elettronica	14.486,00

ARTICOLO	€
----------	---

Trapani/Maschiatrici		
	a colonna tonda foratura acciaio 25 mm maschiatura acciaio 20 M tavola girevole variazione ed avanzamento elettronici IMMVE125ATG	33.591,00
	a colonna tonda foratura acciaio 32 mm maschiatura acciaio 24 M tavola girevole variazione ed avanzamento elettronici IMMVE132ATG	34.206,00

	a colonna tavola mobile foratura acciaio 25 mm maschiatura acciaio 20 M tavola girevole variazione ed avanzamento elettronici IMMVE125ATM	31.858,00
	a colonna tavola mobile foratura acciaio 32 mm maschiatura acciaio 24 M variazione ed avanzamento elettronici IMMVE132ATM	32.475,00

Trapani	
---------	--

	da banco foratura acciaio 10 mm variazione elettronica IMVE110	7.169,00
	da banco foratura acciaio 18 mm variazione elettronica IMVE118	7.969,00
	con basamento foratura acciaio 10 mm variazione elettronica IMVE110C	9.289,00
	con basamento foratura acciaio 18 mm variazione elettronica IMVE118C	10.089,00











ARTICOLO	€
----------	---

Trapani		
	a colonna foratura acciaio 18 mm tavola mobile variazione elettronica IMVE118TM	13.835,00

Unità automatica a controllo	
------------------------------	--

	foratura acciaio 15 mm maschiatura acciaio 12 M UTM18CN	26.600,00
---	--	------------------

ACCESSORI

ARTICOLO	€
 3384020 Visualizzatore di quote digitale DPA21	sostituito da 10.000063
10.000063 Visualizzatore di quote digitale 3 assi NEW	329,28
Attacchi rapidi	
 ARCM1 CM1	281,00
ARCM2 CM2	281,00
ARCM3 CM3	288,00
 ARDB10 DIN B10	213,00
ARDB16 DIN B16	213,00
Portapinza biconica ER32	
 ARPP adatta a pinze EPR32	358,00
Comando automatico a pedale	
CAP per IMMP120	250,00
Pinze elastiche ER32	
 EPR32 capacità 2-20 mm	per quotazioni consultare listino PRT meccanica
Protezioni	
IM153.00 Protezione per trapano IM106-110-115-118	198,00
 IM153.01 Protezione per trapano IM103	198,00
IM153.200 Schermo di ricambio con attacco per art. IM153.00	46,50
IM153.201 Schermo di ricambio con attacco per art. IM153.01	46,50
 IM-AR8 Arresto a revolver	Rich. Offerta
Bussole di trascinamento	
 IMBUS103 per IM103	313,00
 IMBUS106-110 per IM106-110	107,00
IMBUS115-118 per IM115-118	164,30
Micro	
 IMCIE inversione maschiatura emergenza	154,30
 IMCIM inversione maschiatura	157,00
Cinghie trasmissione	
 IMCIN103 per IM103	36,00
IMCIN106-110 per IM106-110	37,00
 IMCIN115-118 per IM115-118	21,90
 IM-MP Mensola portautensili	Rich. Offerta
Molle ritorno canotto	
 IMMRC103 per IM103	21,50
IMMRC106-110 per IM106-110	21,50
IMMRC115-118 per IM115-118	21,50

ARTICOLO	€
Pulegge	
 IMPMA103 lato mandrino per IM103	47,00
 IMPMA106-110 lato mandrino per IM106-110	51,50
 IMPMA115-118 lato mandrino per IM115-118	94,40
 IMPMO103 lato motore per IM103	78,50
 IMPMO106-110 lato motore per IM106-110	51,50
 IMPMO115-118 lato motore per IM115-118	107,30
 IM-STM Sollevamento della tavola motorizzato	Rich. Offerta
Lente d'ingrandimento	
 L per IM103	Rich. Offerta
Mandrini portamaschi	
 MPM0 M3÷M8	398,00
MPM1 M3÷M10	423,00
MPM2 M10÷M20	606,50
Mandrini autoserranti	
 MPP1 0÷6 mm DIN B10	203,00
MPP2 0÷10 mm DIN B16	141,50
MPP3 di precisione 0,2÷10 mm DIN B16	219,00
MPP4 0÷10 mm CM2	93,00
MPP5 0÷13 mm CM3	104,00
Motori	
 MT2V2 a due velocità per IM118	835,70
MTFHP15 autofrenante HP 1,5 per IMMP120	Rich. Offerta
MTHP10 HP 1,0 per IM115-118	621,00
MTHP15 HP 1,5 per IM115-118	621,00
Patrone passo standard	
 PT120SP per IMMP120	Rich. Offerta
PT120ST per IMMP120	Rich. Offerta
PT235SP per IMMP235	Rich. Offerta
PT235ST per IMMP235	Rich. Offerta
Tavola a croce di precisione	
 TC3 piano di lavoro 800x300 mm Corsa: longitudinale 400 mm trasversale 250 mm	Rich. Offerta
Zoccoli rialzo	
 Z100 da 100 mm per trapani da banco	236,00
Z200 da 200 mm per trapani a colonna	558,00